

# GE Series Rail Mounting Single Phase Electric Parameter Transmitter



## Features:

- Can measure single phase voltage/current/power factor/active power/reactive power/appearant power/Kwh etc.
- Measure range: 5-450V , 0.015-5A , Large than 5A , please match with Ct.
- Optional one loop 4-20mA analog output.
- Optional R485 Communication , adopt national standard Modbus-RTU procotel.
- Voltage and ampere signal measurement use electromagnet technology : detailed isolation mode is as blow:

1. DC24V±5% power supply

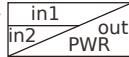

2. 100-240V AC/DC power supply

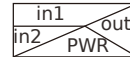

For your safe, please read the below content carefully before you use the product !

## ■ Safety

※ Please read the manual carefully before you use the meter!

※ Please obey the following points

⚠ Warn An accident may happen , if not obey the instructions

⚠ Note If not obey the instructions , the product may be damaged

※ The instruction of the symbol in the manual is as below:

⚠ An accident or danger may happen in a special condition.

## ⚠ Warning

- 1.A safty protection equipment must be installed or please contact with us for the relative information if the product is used under the circumstance such as nuclear control , medical treatment equipment, automobile, train, airplane, aviation, entertainment or safty equipment, etc. Otherwise, it may cause serious loss .
- 2.A panel must be installed, otherwise it may cause creepage (leakage).
- 3.Do not touch wire connectors when the power is on, otherwise you may get an electric shock.
- 4.Please check the connection number while you connect the power supply wire or input signal, otherwise it may

## ⚠ Caution

- 1.This product cannot be used outdoors. Otherwise the working life of the product will become shorter, or an electric shock accident may happen.
- 2.When connect to power or signal input , screw No.20AWG ( 0.50mm ) should be tweaked at 0.74n-m - 0.9n-m of the terminal moment force, otherwise it may be damaged or get fire .
- 3.Please comply with the rated specification. Otherwise it may cause fire or the working life of the product will become shorter .
- 4.Do not use water or oil base cleaner to clean the product. Otherwise it may cause electric shock or fire, and damage the product.
- 5.This product should avoid working under the circumstance that is flammable, explosive, moist, under sunshine, heat radiation and vibration. Otherwise it may cause explosion.
6. In this unit it must not have dust or deposit, otherwise it may cause fire or mechanical malfunction.
- 7.Do not use gasoline, chemical solvent to clean the cover of the product because such solvent can damage it . Please use some soft cloth with water or alcohol to clean the plastic cover .

## ■ Model Illustration

GE2□L □□-4MA20/RS4

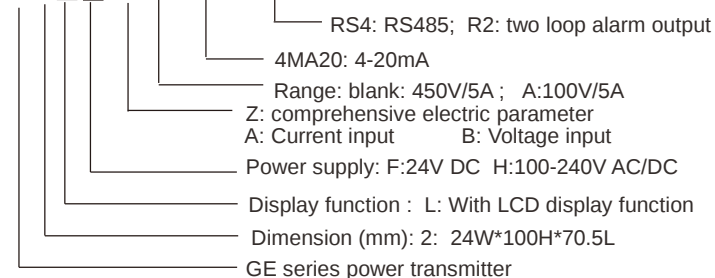

## ■ Model Composition

Model	Main output	Other output
GE2□L-□□-4MA20/RS4	4-20mA	RS485
GE2□L-□□-4MA20/R2	4-20mA	2 Alarm output

Relay output capacity is 250V AC/30 DC, 3A. To make sure the long life of the relay , it is better to be used 250V AC/ 30V DC , 1A in long time usage.

## ■ Technical Specification

Suitable power grid	Single phase 50/60Hz
Maximum rated Voltage	450V
	Continuous: 1.2 times Instantaneous: 2 times/10S
Voltage Consumption	<1VA
Voltage Imdepance	>300KΩ
Voltage Accuracy	RMS measurement , Accuracy : 0.5
Maximum rated current	5A
Current Overload	Continuous: 1.2 times Instantaneous: 10 times/10S
Current Consumption	< 0.4VA
Current Imdepance	<20mΩ
Current Accuracy	RMS measurement, Accuracy 0.5
Other parameter accuracy	Active power/reactive power/apparent power/power factor/Kwh accuracy 1%F.S.
Voltage overload	LCD Display
Power working range	DC 24V±5% or 100-240V AC/DC, Power will affect measuring accuracy , please use stable power.
Digital ouput interface	Standard RS-485 Modbus-RTU
Analog Output	1 transformed analog output, 4-20mA DC . Accuracy: 0.5% F.S
Storage Environment	-10 ~ 60°C
Working Environment	
Isolation&puncture	Input signal and power 1600V AC , Input and output 1600VAC , DC 24V power supply and transformed analog output no isolation Input , output , power against meter cover > 5MΩ
Dimension	24WX100LX70.5L
Weight	300g

## ■ Panel Indication

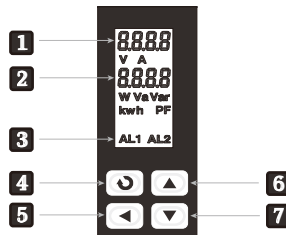

No.	Symbol	Name	Function
1	8888	Display window 1	Display measuring parameters and menu name
2	8888	Display window 2	Display measuring unit or menu setting vaule
3	AL1,AL2	Alarm	When display AL1/AL2 , the meter make alarm and relay will output.
4		Set Key	In measuring status , keep pressing 3 seconds to enter into menu operation status. It used as menu selection key or modification confirmation key in menu operation .
5		Shift Key	In measuring status , pressing this key can switch the display . In the menu setting status , pressing this key to flash the modified value.
6		Increase Key	In menu setting status , pressing this key can increase the set value
7		Decrease Key	In menu setting status , pressing this key can decrease the set value

## ■ Operate sequences

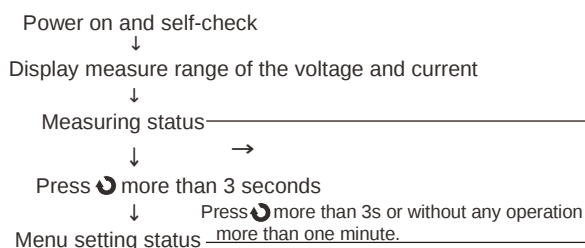

How to modify the parameters :

- ◆ How to change the setting value :  
In setting status , press to choose the menu needing modified. Then press to shift ,then press / to modify the needed value; When all the 4 digits datas modified , press to confirm and enter next menu
- ◆ How to change the decimal point :  
In setting status , press to make the needing data flick .Then press + or + to change the position of the decial point .
- ◆ How to clear the Kwh  
In measuring status , press + for more than 3s to enter PSD menu , input "111" to confirm the clearance

## ■ Detailed Illustration for setting the menu

Turn on power

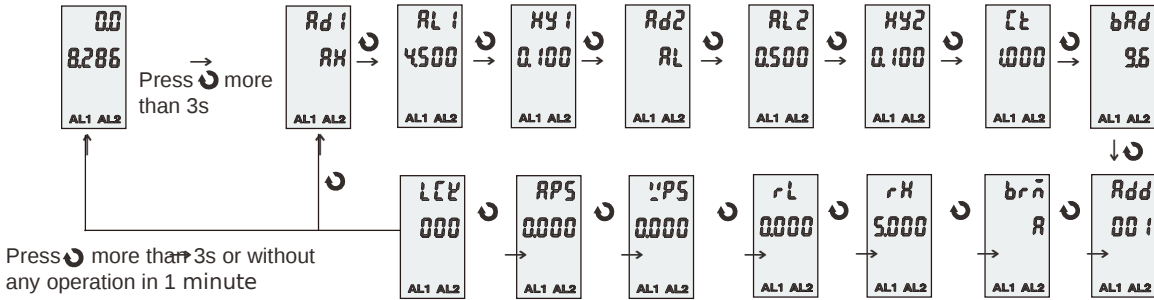

Set item	Menu	Value range	Illustration	Factory setting
The first alarm	Ad1	AL ~ PFH	How to set the 1st alarm mode: AL:Low limit alarm of current AH:High limit alarm of current VL:Low limit alarm of voltage AH:High limit alarm of voltage KWHL: Low limit alarm of KWH KWHH:High limit alarm of KWH VAL:Low limit alarm of apparent power KVAH:High limit alarm of apparent power VARL:Low limit alarm of reactive power VARH:High limit alarm of reactive power KWL:Low limit alarm of active power KWH:High limit alarm of active power PFL:Low limit alarm of power factor PFH:High limit alarm of power factor	AH
	AL1	-1999 ~ 9999	Menu for setting the 1st alarm . Eg:If the 1st alarm mode Ad1 set to VH , and AL1 set to 300, when the measured value $\geq$ 300, it will alarm	90%F.S
	HY1	-1999 ~ 9999	Menu for setting 1st alarm hysteresis .Eg:If alarm mode Ad1 set to VH, and AL1 set to 300,HY1 set to 10 , when the measured voltage $\leq$ (300-10), It will stop alarm .Note:Other alarm mode setting is the same as above	0.100
The second alarm	Ad2	AL ~ PFH	Refer to Ad1	AL
	AL2	-1999 ~ 9999	Refer to AL1	10%F.S
	HY2	-1999 ~ 9999	Refer to HY1	0.100
Current transfer rate	Ct	1.0 ~ 1999	Set the current transfer rate . Eg:20/5=4.000,that's when the measured current is 20A, and set CT to 4.000 . Note : The transformer should be bought in addition .	1.000
Communication RS485	bAd	9.6/4.8	Baud rate .Baud rate is:4.8Kbit, 9.6Kbit;	9.6
	Add	0 ~ 255	Communication address	001
Analog output 4 ~ 20mA	brm	A ~ PF	Analog mode selection . All the items can be set to analog freely A:Current analog, V:Voltage analog, KVA:Apparant power analog, KVAR:Reactive power analog, KW:Active power analog, PF:Power factor analog (the begin unit of the power factor analog is K ) Eg.1.000 is 1000W	A
	rH	-1999 ~ 9999	High limit value setting for analog.If analog mode set to voltage transfer, this value should be high limit value of the measured voltage	5
	rL	-1999 ~ 9999	Low limit value setting for analog.If analog mode set to voltage transfer, this value should be low limit value of the measured voltage	0.000
Compensation	VPS	-1999 ~ 9999	Voltage amend value . Display value=Measured value+VPS	0.000
	APS	-1999 ~ 9999	Voltage amend value . Display value=Measured value+APS	0.000
Password Lock	LCK	0 ~ 255	Password Lock.Set 000 , the value can be modified . Set 010 ,the value can not be modified .Set 123 , recover the factory value after on power.	000

## ■ Dimension

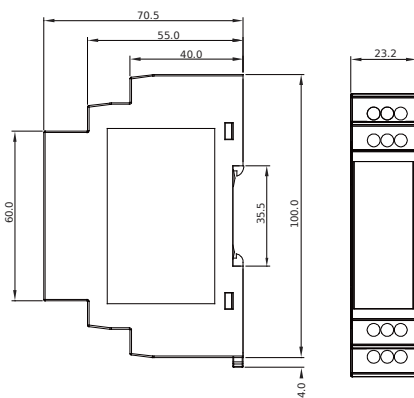

W×H×L=23.2×110.0×70.5(mm)

## ■ Connecting Drawing

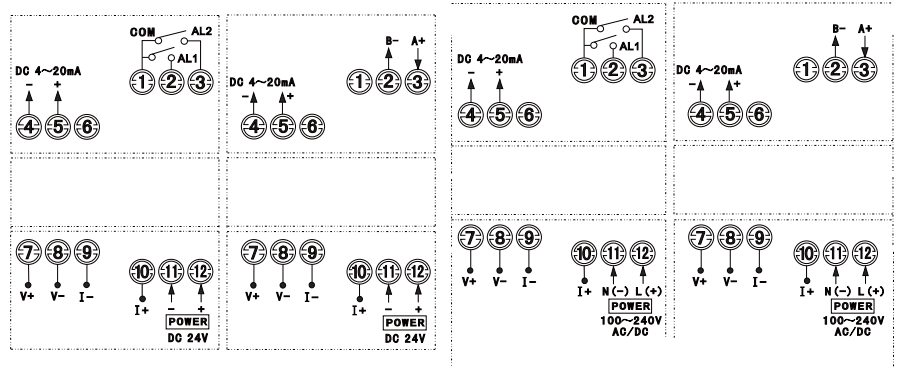

DC24V Power Supply

100-240V AC/DC power supply

## ■ Communication

GE2 Series products adopt Modbus RTU protocol , RS485 half duplex communication , read function code 0x03 , write function code 0x0A , Adopt 16 digits CRC checking , the meter will not return when check error .

Data frame format :

Start bit	Data bit	Stop bit	Check bit
1	8	1	Without

Communication abnormal shooting :

When the answer is abnormal , the high bit of the function code will be set to 1. Eg:The request function code from the master unit is 0x04, and the slave unit will return a function code 0x84 accordingly .

Error code type

0x01---Function code illegal :The meter can not support the received function code .

0x02---Position of the data illegal :The specified position of the master unit exceeds the the range of the meter .

0x03---Data value illegal : The data value which is sent by the master unit exceeds the data range of the meter .

### 1、 Read multi-register

Eg : Master unit read float data AL1 ( 1st alarm value 241.5)

The address code of AL1 is 0x0000, because AL1 is float data (4 bytes) ,it takes up 2 registers .The IEEE-754 standard hexadecimal memory code of the decimal point data 241.5 is 0x00807143

Master unit request ( Read multiple register )									
1	2	3	4	5	6	7	8		
meter address	function code		high bit of the start address	low bit of the start address		high bit of the data length	low bit of the data length	low bit of CRC code	high bit of CRC code
0x01	0x03		0x00	0x00	0x00	0x02	0xC4	0x0B	

Slave unit normal response ( Read multi-register )											
1	2	3	4	5	6	7	8	9			
meter address	function code		byte No. of the data	high bit of data 1	low bit of data 1		high bit of data 2	low bit of data 2		low bit of CRC code	high bit of CRC code
0x01	0x03		0x04	0x00	0x80	0x71		0x43	0x9E	0x7A	

Response for function code error:(Eg.The request function code is 0x04)

Slave unit abnormal response(Read multi-register)					
1	2	3	8	9	
address of the meter	Function code		Error code	Low bit of CRC code	High bit of CRC code
0x01	0x84		0x01	0x82	0xC0

### 2、 Read multi-register

Eg : Master unit read float point HY1 ( 1st alarm hysteresis is 20.5)

Address code of HY1 is 0x0001, because HY1 is float point data (4 byte), taking up 2 data registers.The IEEE-754 standard hexadecimal memory code of decimal float data 20.5 is 0x0000A441

Master unit request ( Read multi-register )															
1	2	3	4	5	6	7	8	9	10	11	12	13			
meter address	function code	high bit of start address	low bit of start address	high bit of byte length	low bit of byte length		length of data byte	high bit of data 1	low bit of data 1		high bit of data 2	low bit of data 2		low bit of CRC	high bit of CRC
0x01	0x10	0x00	0x01	0x00	0x02	0x04	0x00	0x00	0x00	0xA4	0x41	0x88	0x93		

slave unit normal response(write multi-register)									
1	2	3	4	5	6	7	8		
Meter address	Function code		high 8 bits of start address	low 8 bits of start address		high bit of data length	low bit of data length	low bit of CRC code	high bit of CRC code
0x01	0x10		0x00	0x01	0x00	0x02	0x10	0x08	

Data position wrong response:( Eg:Master unit request address index is 0x0050 )

Slave unit wrong answer ( write multi-register )					
1	2	3	4	5	
Meter address	Function code		Error code	low bit of CRC code	high bit of CRC code
0x01	0x90		0x02	0xCD	0xC1

GE2 Reflection for some parameters address

Note:Address code equals to the index of the array variable

S/N	Address reflection	Variable name	Byte length	Value range	Read/write allow	Remark
0	0x0000	1st alarm value AL1	2	-1999 ~ 9999	R/W	
1	0x0001	1st alarm hysteresis HY1	2	-1999 ~ 9999	R/W	
2	0x0002	2nd alarm value AL2	2	-1999 ~ 9999	R/W	
3	0x0003	2nd alarm hysteresis HY2	2	-1999 ~ 9999	R/W	
4	0x0004	current coefficient Ct	2	0 ~ 9999	R/W	
5	0x0005	high limit analog value rH	2	-1999 ~ 9999	R/W	
6	0x0006	low limit analog value rL	2	-1999 ~ 9999	R/W	
7	0x0007	voltage amendment value VPS	2	-1999 ~ 9999	R/W	
8	0x0008	ampere amendment value APS	2	-1999 ~ 9999	R/W	
9	0x0009	full measure range of voltage FSV	2	0.000 ~ 9999	R	
10	0x000A	full measure range FSA	2	0.000 ~ 9999	R	
11	0x000B	effective value of voltage	2	0.000 ~ 9999	R	
12	0x000C	effective value of ampere	2	0.000 ~ 9999	R	
13	0x000D	power factor	2	-1.0 ~ 1.0	R	
14	0x000E	active power	2	0.000 ~ 9999	R	
15	0x000F	reactive power	2	0.000 ~ 9999	R	
16	0x0010	apparent power	2	0.000 ~ 9999	R	
17	0x0011	Kwh	2	0.000 ~ 9999	R	
reservation						
21	0x0015	1st alarm mode Ad1	1	0 ~ 13	R/W	Note①
22	0x0016	2nd alarm mode Ad2	1	0 ~ 13	R/W	Note①
23	0x0017	analog mode brM	1	0 ~ 5	R/W	Note②
24	0x0018	Menu lock LCK	1	0 ~ 255	R/W	
25	0x0019	baud rate bAd	1	0 ~ 1	R	Note③
26	0x001A	Meter address Add	1	0 ~ 255	R	
27	0x001B	alarm output status	1	0 ~ 255	R	Note④
28	0x001C	name of the meter	1	0xE2	R	
reservation						

R/W---Read and Write

R----Read only

Note① :Alarm mode

High limit alarm	communication value	low limit alarm	communication value	alarm item
VH	0	VL	1	voltage
AH	2	AL	3	ampere
PFH	4	PFL	5	power factor
KWH	6	KWL	7	active power
VArH	8	VArL	9	reactive poer
VAH	10	VAL	11	apparent power
KWHH	12	KWHL	13	Kwh

Note ② analog mode

communication value	0	1	2	3	4	5
displayed menu	V	A	PF	KW	KVAr	KVA
analog item	voltage value	ampere value	power factor	active power	reactive power	apparent power

Note③: baud rate

communication value	0	1
displayed menu	4.8	9.6

Note④ alarm status

D7	D6	D5	D4	D3	D2	D1	D0	
							AL2	AL1

**The program of 4 byte character code float data converts to decimalist float data**

```
float BytesToFloat(unsigned char*pch)
{
    float result;
    unsigned char *p;
    p=(unsigned char*)&result;
    * p=*pch;*(p+1)=*(pch+1);*(p+2)=*(pch+2);*(p+3)=*(pch+3);
    return result;
}
```

**The program of decimalist float data converts to 4 byte character code as IEEE-754 standards .**

```
void FloatToChar(float Fvalue,unsigned char*pch)
{
    unsigned char*P;
    p=(unsigned char*)&Fvalue;
    *pch=*p;*(pch+1)=*(p+1);*(pch+2)=*(p+2);*(pch+3)=*(p+3);
}
```

**Program of obtaining 16 digits CRC checking code**

```
unsigned int Get_CRC (uchar*pBuf,uchar num)
{
    unsigned i,j;
    unsigned int wCrc=0xFFFF;
    for(i=0;i<num;i++)
    {
        wCrc^=(unsigned int)(pBuf[i]);
        for(j=0;j<8;j++)
        {
            if(wCrc &1){wCrc>>=1; wCrc=0xA001;}
            else wCrc>>=1;
        }
    }
    return wCrc;
}
```

**■ Display of showing 26 English letters with 7 segments LED :**

Letter	A	B	C	D	E	F	G	H	I	J	K	L	M			
LED Display	<i>A</i>	<i>b</i>	<i>C</i>	<i>d</i>	<i>E</i>	<i>F</i>	<i>G</i>	<i>H</i>	<i>I</i>	<i>J</i>	<i>K</i>	<i>L</i>	<i>M</i>			
Letter	N	O	P	Q	R	S	T	U	V	W	X	Y	Z			
LED Display	<i>n</i>	<i>o</i>	<i>P</i>	<i>q</i>	<i>r</i>	<i>S</i>	<i>t</i>	<i>U</i>	<i>v</i>	<i>w</i>	<i>X</i>	<i>Y</i>	<i>Z</i>			

**■ Cautions :**

- 1、 In order to make the operation easier , it is better to connect terminal 10, 11, 12 , 1, 2, 3 firstly .
- 2、 Accurate measuring condition : ambient temperature 25°C±3°C, humidity 60%RH, city voltage±15% or above 60% of the standard voltage .
- 3、 Wiring should refer to the connecting drawing on the ex-factory meter .
- 4、 The meter has thunder proof ability , but in some severe condition , a thunder proof equipment is needed to make sure the safety .
- 5、 The meter can not be used in the ambience with strong electric field and strong magnetic field to avoid damage .
- 6、 The meter can measure active power in AC sina circuit, if there is much distortion of the voltage or current , then it can not be measured .